

CAM-1000

Serial Digital Camera for Remote Visual Alarm Verification



Vivision®

Installation Instructions

1. INTRODUCTION

The CAM-1000 is a small digital camera designed for use in security systems. It enables the user to see picture of the desired area from remote location.

The camera sends compressed (still) picture by RS-485 serial communication format.

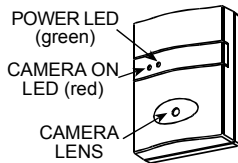

Figure 1 - External View

Note: The CAMERA ON LED flashes during camera activation.

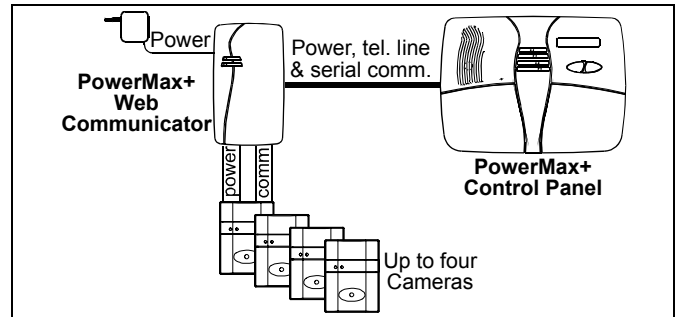

Figure 2 - Integration with PowerMax+ Web Communicator

2. SPECIFICATIONS

Camera Type: VGA (640x480)

View Angle: 60 degrees

Sensitivity: 1,12 V/Lux-sec

Power Supply: 12 VDC (supplied from PowerMax control panel via Web Communicator unit).

Picture Format: Compressed JPEG color

Current Consumption @ 12VDC: 10mA (Standby), 40mA (ON)

Communication Format: Serial, RS-485

Baud Rate: 38400 bps

Mounting Types: Surface mounting, surface mounting with BR-1 swivel bracket (supplied), corner mounting with BR-2 swivel bracket or ceiling mounting with BR-3 swivel bracket.

Dimensions (HxWxD): 68 x 51 x 23 mm (2-11/16 x 15/16 x 7/8 in)

Color: White

Weight: 75 g (2.65 oz)

Operating Temperature: -10°C to 70°C (14°F to 158°F)

Stable Image Temperature: 0°C to 50°C (32°F to 122°F)

Compliance with Standards: FCC, CE: EN-50131/5/3

3. DIP SWITCHES SETUP

The Camera includes DIP switches as follows:

- DIP switches 1 and 2 enable the installer to define the number of the camera (No. 1, 2, 3 or 4). It is important that this definition will be done before the wiring, according to the camera planned location.
- DIP switches 3 and 4 enable the installer to disable the activity of the "POWER" and "CAMERA ON" LEDs, to prevent an intruder of knowing that the camera is active.

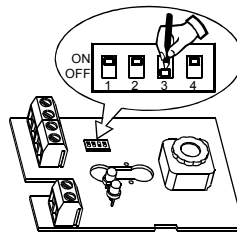

Figure 3 - DIP Switches Setup

DIP Switches Setup

Setting	DIP Switches			
	1	2	3	4
Camera #1	ON	ON	-	-
Camera #2	ON	OFF	-	-
Camera #3	OFF	ON	-	-
Camera #4	OFF	OFF	-	-
"Camera ON" LED - ON	-	-	ON	-
"Camera ON" LED - OFF	-	-	OFF	-
"Power LED" - ON	-	-	-	ON
"Power LED" - OFF	-	-	-	OFF

4. MOUNTING

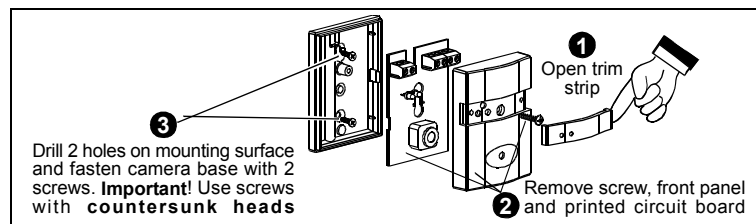

Figure 4 - Surface Mounting

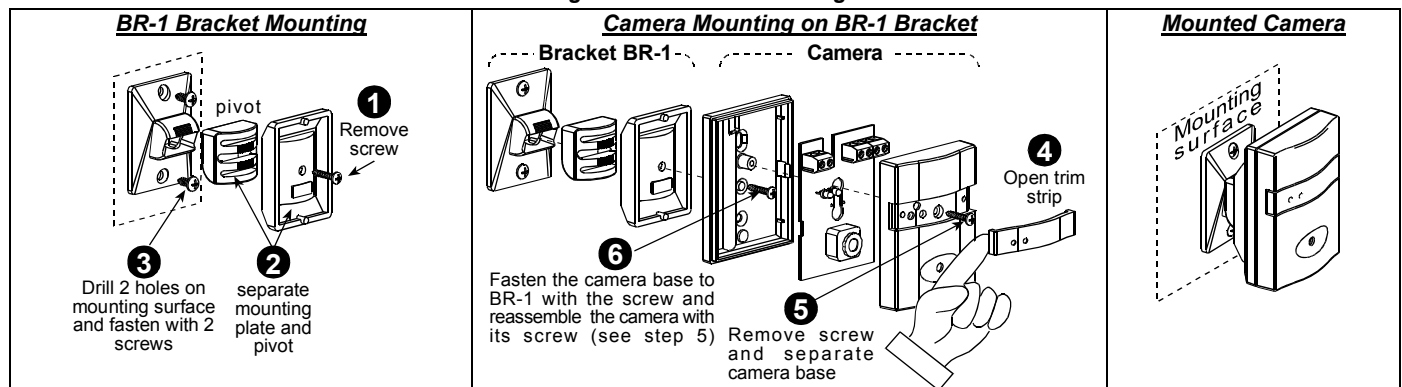

Figure 5 - Surface Mounting with BR-1 Swivel Bracket

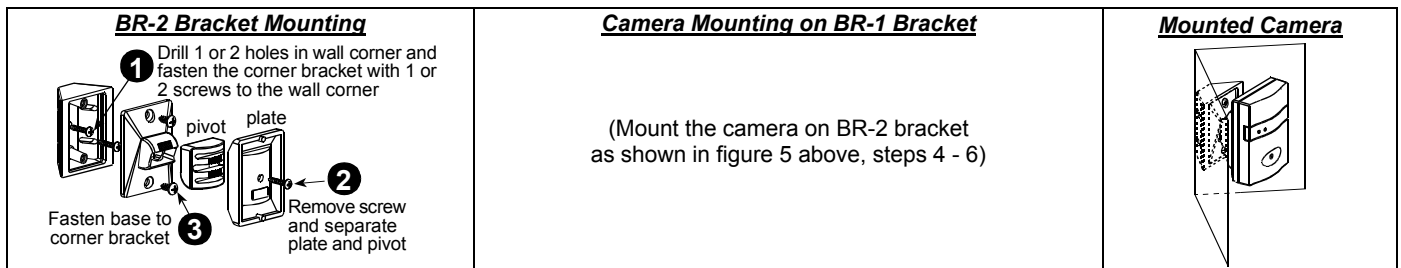

Figure 6 – Corner Mounting with BR-2 Swivel Bracket

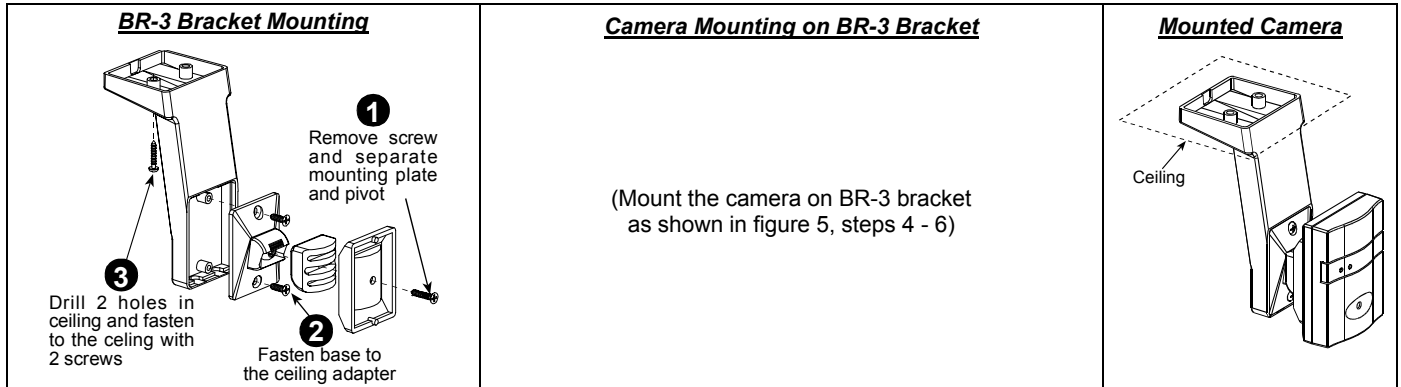

Figure 7 – Ceiling Mounting with Swivel Bracket BR-3

5. WIRING

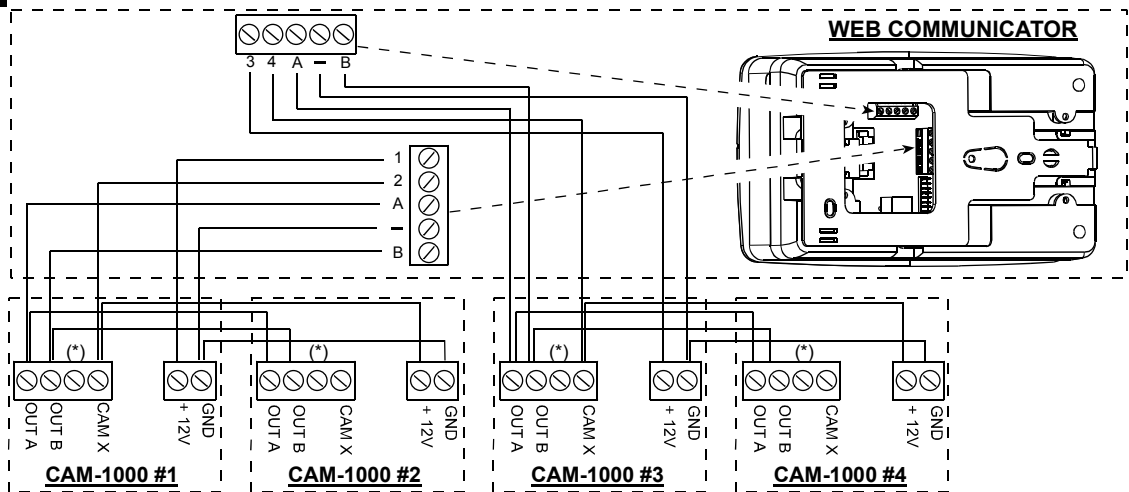

Figure 8 – Wiring to Web Communicator

WARRANTY

Visonic Ltd. and/or its subsidiaries and its affiliates ("the Manufacturer") warrants its products hereinafter referred to as "the Product" or "Products" to be in conformance with its own plans and specifications and to be free of defects in materials and workmanship under normal use and service for a period of twelve months from the date of shipment by the Manufacturer. The Manufacturer's obligations shall be limited within the warranty period, at its option, to repair or replace the product or any part thereof. The Manufacturer shall not be responsible for dismantling and/or reinstallation charges. To exercise the warranty the product must be returned to the Manufacturer freight prepaid and insured.

This warranty does not apply in the following cases: improper installation, misuse, failure to follow installation and operating instructions, alteration, abuse, accident or tampering, and repair by anyone other than the Manufacturer.

This warranty is exclusive and expressly in lieu of all other warranties, obligations or liabilities, whether written, oral, express or implied, including any warranty of merchantability or fitness for a particular purpose, or otherwise. In no case shall the Manufacturer be liable to anyone for any consequential or incidental damages for breach of this warranty or any other warranties whatsoever, as aforesaid.

This warranty shall not be modified, varied or extended, and the Manufacturer does not authorize any person to act on its behalf in the modification, variation or extension of this warranty. This warranty shall apply to the Product only. All products, accessories or attachments of others used in conjunction with the Product, including batteries, shall be covered solely by their own warranty, if any. The Manufacturer shall not be liable for any damage or loss whatsoever, whether directly, indirectly, incidentally, consequentially or otherwise, caused by the malfunction of the Product due to products, accessories, or attachments of others, including batteries, used in conjunction with the Products.

The Manufacturer does not represent that its Product may not be compromised and/or circumvented, or that the Product will prevent any death, personal and/or bodily injury and/or damage to property resulting from burglary, robbery, fire or otherwise, or that the Product will in all cases provide adequate warning or protection. User understands that a properly installed and maintained alarm may only reduce the risk of events such as burglary, robbery, and fire without warning, but it is not insurance or a guarantee that such will not occur or that there will be no death, personal damage and/or damage to property as a result.

The Manufacturer shall have no liability for any death, personal and/or bodily injury and/or damage to property or other loss whether direct, indirect, incidental, consequential or otherwise, based on a claim that the Product failed to function. However, if the Manufacturer is held liable, whether directly or indirectly, for any loss or damage arising under this limited warranty or otherwise, regardless of cause or origin, the Manufacturer's maximum liability shall not in any case exceed the purchase price of the Product, which shall be fixed as liquidated damages and not as a penalty, and shall be the complete and exclusive remedy against the Manufacturer.

Warning: The user should follow the installation and operation instructions and among other things test the Product and the whole system at least once a week. For various reasons, including, but not limited to, changes in environmental conditions, electric or electronic disruptions and tampering, the Product may not perform as expected. The user is advised to take all necessary precautions for his /her safety and the protection of his/her property.

6/91



W.E.E.E. Product Recycling Declaration

For information regarding the recycling of this product you must contact the company from which you originally purchased it. If you are discarding this product and not returning it for repair then you must ensure that it is returned as identified by your supplier. **This product is not to be thrown away with everyday waste.** Directive 2002/96/EC Waste Electrical and Electronic Equipment.



Visonic®

VISONIC LTD. (ISRAEL): P.O.B 22020 TEL-AVIV 61220 ISRAEL. PHONE: (972-3) 645-6789, FAX: (972-3) 645-6788
 VISONIC INC. (U.S.A.): 65 WEST DUDLEY TOWN ROAD, BLOOMFIELD CT. 06002-1376. PHONE: (860) 243-0833, (800) 223-0020 FAX: (860) 242-8094
 VISONIC LTD. (UK): FRASER ROAD, PRIORY BUSINESS PARK, BEDFORD MK44 3WH. PHONE: (0870) 7300800 FAX: (0870) 7300801
 INTERNET: www.visonic.com

©VISONIC LTD. 2005 CAM-1000, DE5941- (REV. 1, 3/05)



MADE IN ISRAEL